

Information about BOSCH CRI with IQA-Function

ANDORIA

Image Caption:

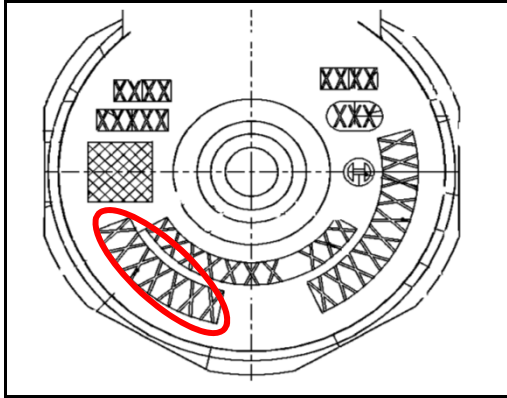

Affected Injector SNr.:

0 445 110 312	

IQA-Code: (Example)

7RRX8I5	
Position 1:	IQA-Code, Mandatory Input
Position 2:	IQA-Code, Mandatory Input
Position 3:	IQA-Code, Mandatory Input
Position 4:	IQA-Code, Mandatory Input
Position 5:	IQA-Code, Mandatory Input
Position 6:	IQA-Code, Mandatory Input
Position 7:	IQA-Code, Mandatory Input
Position 8:	Not Used
Position 9:	Not Used
Position 10:	Not Used

Font Information:

Regular type according to DIN 1451
with crossed out Zero

Remarks:

Information about BOSCH CRI with IQA-Function

Image Caption:

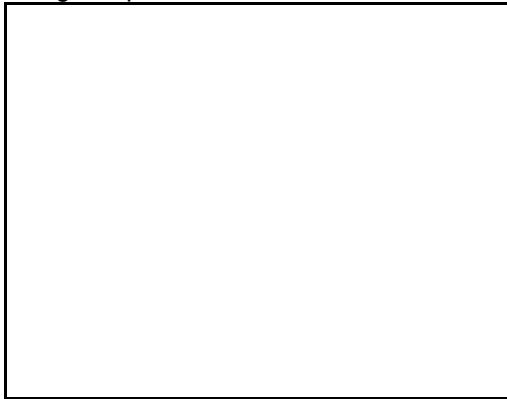

Affected Injector SNr.:

IQA-Code: (Example)

Position 1:	
Position 2:	
Position 3:	
Position 4:	
Position 5:	
Position 6:	
Position 7:	
Position 8:	
Position 9:	
Position 10:	

Font Information:

Remarks:

Information about BOSCH CRI with IQA-Function

AUDI

Image Caption:

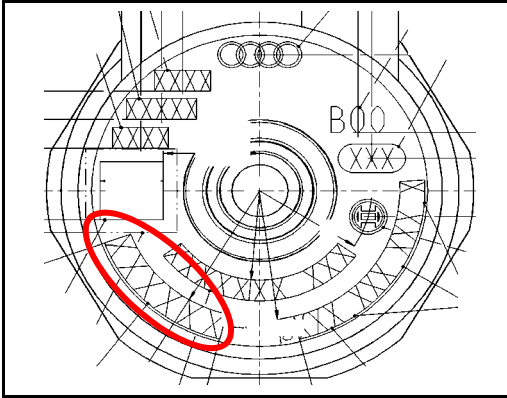

Affected Injector SNr.:

0 445 110 157	
0 445 110 158	

IQA-Code: (Example)

6G8M3A	
Position 1:	IQA-Code, Mandatory Input
Position 2:	IQA-Code, Mandatory Input
Position 3:	IQA-Code, Mandatory Input
Position 4:	IQA-Code, Mandatory Input
Position 5:	IQA-Code, Mandatory Input
Position 6:	IQA-Code, Mandatory Input
Position 7:	Not Used
Position 8:	Not Used
Position 9:	Not Used
Position 10:	Not Used

Font Information:

--

Remarks:

--

Information about BOSCH CRI with IQA-Function

Image Caption:

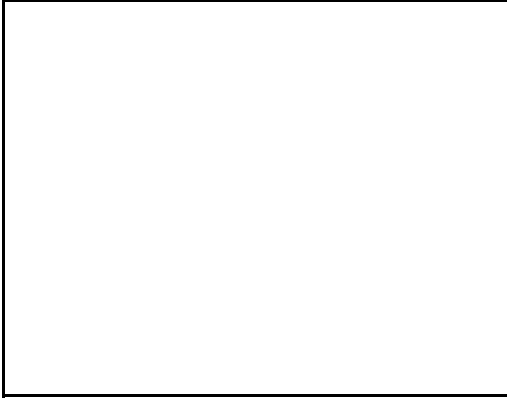

Affected Injector SNr.:

IQA-Code: (Example)

Position 1:	
Position 2:	
Position 3:	
Position 4:	
Position 5:	
Position 6:	
Position 7:	
Position 8:	
Position 9:	
Position 10:	

Font Information:

--

Remarks:

--

Information about BOSCH CRI with IQA-Function

BMW

Image Caption:

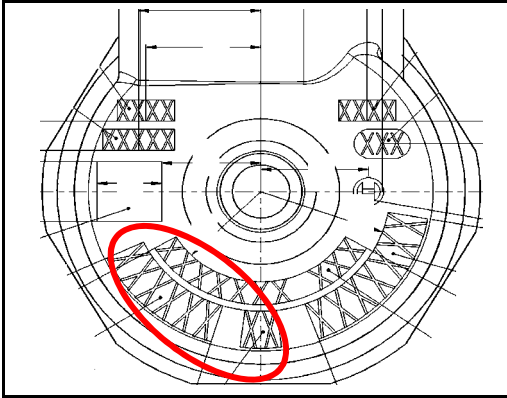

Affected Injector SNr.:

0 445 110 131	
0 445 110 080	
0 445 110 122	
0 445 110 149	

IQA-Code: (Example)

BA2EDS G1	
Position 1:	IQA-Code, Mandatory Input
Position 2:	IQA-Code, Mandatory Input
Position 3:	IQA-Code, Mandatory Input
Position 4:	IQA-Code, Mandatory Input
Position 5:	IQA-Code, Mandatory Input
Position 6:	IQA-Code, Mandatory Input
Position 7:	Class designation, no opinion
Position 8:	Class designation, no opinion
Position 9:	Not Used
Position 10:	Not Used

Font Information:

Regular type according to DIN 1451
with crossed out Zero

Remarks:

Information about BOSCH CRI with IQA-Function

BMW

Image Caption:

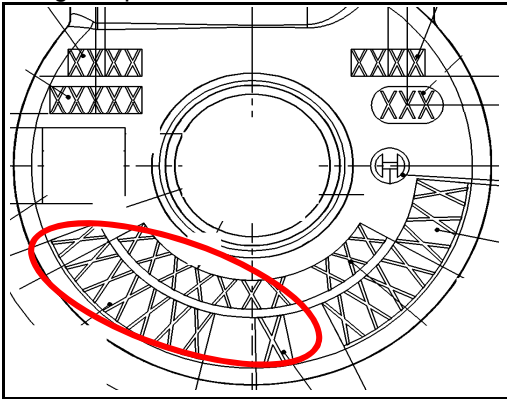

Affected Injector SNr.:

0 445 110 209	
0 445 110 212	
0 445 110 216	
0 445 110 219	
0 445 110 161	

IQA-Code: (Example)

7RRX8I5 L	
Position 1:	IQA-Code, Mandatory Input
Position 2:	IQA-Code, Mandatory Input
Position 3:	IQA-Code, Mandatory Input
Position 4:	IQA-Code, Mandatory Input
Position 5:	IQA-Code, Mandatory Input
Position 6:	IQA-Code, Mandatory Input
Position 7:	IQA-Code, Mandatory Input
Position 8:	Identifier, no opinion
Position 9:	Not Used
Position 10:	Not Used

Font Information:

Regular type according to DIN 1451
with crossed out Zero

Remarks:

Information about BOSCH CRI with IQA-Function

BMW

Image Caption:

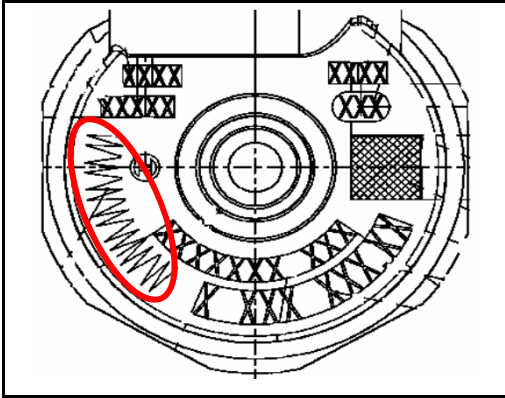

Affected Injector SNr.:

0 445 110 289	
0 445 110 401	
0 445 110 382	
0 445 110 478	
0 445 110 479	
0 445 110 480	
0 445 110 596	
0 986 435 207	
0 445 110 616	
0 445 110 617	
0 986 435 244	
0 445 110 595	

IQA-Code: (Example)

7RRX8I5	
Position 1:	IQA-Code, Mandatory Input
Position 2:	IQA-Code, Mandatory Input
Position 3:	IQA-Code, Mandatory Input
Position 4:	IQA-Code, Mandatory Input
Position 5:	IQA-Code, Mandatory Input
Position 6:	IQA-Code, Mandatory Input
Position 7:	IQA-Code, Mandatory Input
Position 8:	Not Used
Position 9:	Not Used
Position 10:	Not Used

Font Information:

Regular type according to DIN 1451
with crossed out Zero

Remarks:

Information about BOSCH CRI with IQA-Function

Image Caption:

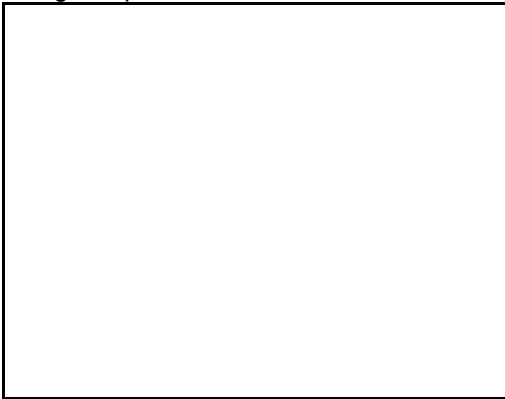

Affected Injector SNr.:

IQA-Code: (Example)

Position 1:	
Position 2:	
Position 3:	
Position 4:	
Position 5:	
Position 6:	
Position 7:	
Position 8:	
Position 9:	
Position 10:	

Font Information:

Remarks:

Information about BOSCH CRI with IQA-Function

CHINA

Image Caption:

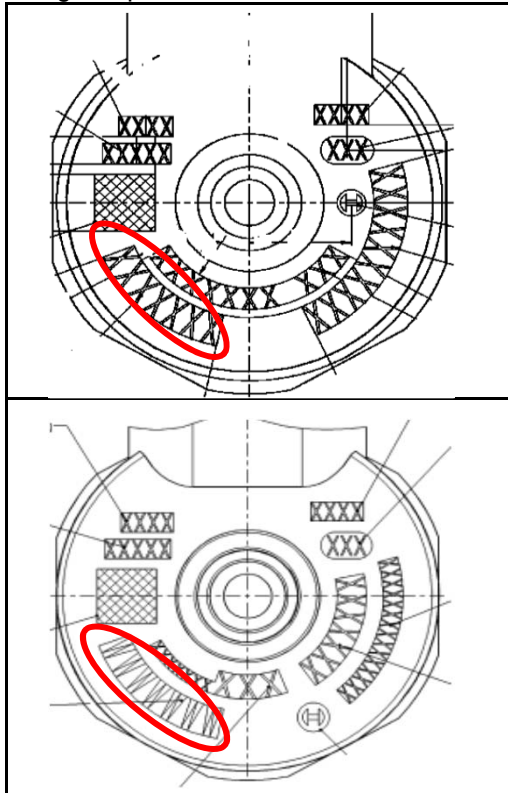

Affected Injector SNr.:

0 445 110 293	0 445 110 447
0 445 110 304	0 445 110 448
0 445 110 305	0 445 110 449
0 445 110 313	0 445 110 454
0 445 110 317	0 445 110 462
0 445 110 318	0 445 110 481
0 445 110 321	0 445 110 482
0 445 110 333	0 445 110 483
0 445 110 335	0 445 110 484
0 445 110 335	0 445 110 486
0 445 110 343	0 445 110 512
0 445 110 344	0 445 110 515
0 445 110 345	0 445 110 521
0 445 110 346	0 445 110 541
0 445 110 347	0 445 110 628
0 445 110 348	0 445 110 629
0 445 110 355	0 445 110 630
0 445 110 356	0 445 110 631
0 445 110 357	0 445 110 669
0 445 110 361	0 445 110 670
0 445 110 362	0 445 110 691
0 445 110 363	0 445 110 710
0 445 110 364	0 445 110 511
0 445 110 365	0 445 110 510
0 445 110 370	
0 445 110 372	
0 445 110 379	
0 445 110 380	
0 445 110 387	
0 445 110 388	
0 445 110 409	
0 445 110 412	
0 445 110 420	
0 445 110 421	
0 445 110 422	
0 445 110 442	
0 445 110 443	
0 445 110 445	
0 445 110 446	

IQA-Code: (Example)

7RHH3A5	
Position 1:	IQA-Code, Mandatory Input
Position 2:	IQA-Code, Mandatory Input
Position 3:	IQA-Code, Mandatory Input
Position 4:	IQA-Code, Mandatory Input
Position 5:	IQA-Code, Mandatory Input
Position 6:	IQA-Code, Mandatory Input
Position 7:	IQA-Code, Mandatory Input
Position 8:	Not Used
Position 9:	Not Used
Position 10:	Not Used

Font Information:

Regular type according to DIN 1451
with crossed out Zero

Remarks:

FAW	DFMCY	Naveco
FOTON	JAC	GoNow
JMC	YANGCHAI	CHERY
JME	CHERY	SDEC
YUNNEI	GREATWALL	Qingling
XINCHEN	Yuachai	Yuchai
L Aidong	Huatai	Shanghai

Information about BOSCH CRI with IQA-Function

CUMMINS

Image Caption:

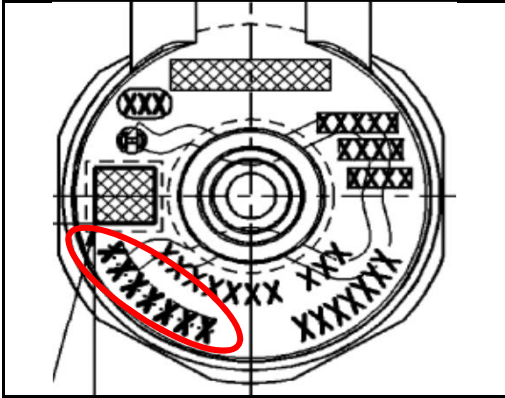

Affected Injector SNr.:

0 445 110 376	
0 445 110594	

IQA-Code: (Example)

8RIX71C	
Position 1:	IQA-Code, Mandatory Input
Position 2:	IQA-Code, Mandatory Input
Position 3:	IQA-Code, Mandatory Input
Position 4:	IQA-Code, Mandatory Input
Position 5:	IQA-Code, Mandatory Input
Position 6:	IQA-Code, Mandatory Input
Position 7:	IQA-Code, Mandatory Input
Position 8:	Not Used
Position 9:	Not Used
Position 10:	Not Used

Font Information:

OCR-A according to DIN66008

Remarks:

Information about BOSCH CRI with IQA-Function

Image Caption:

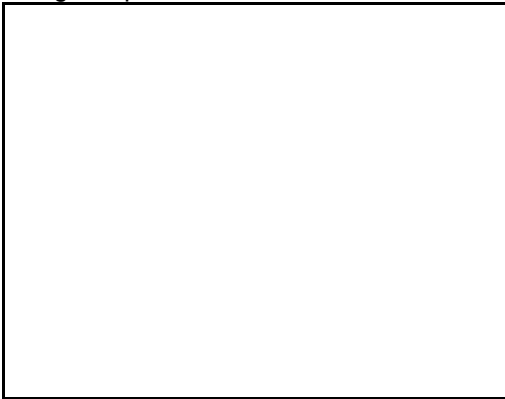

Affected Injector SNr.:

IQA-Code: (Example)

Position 1:	
Position 2:	
Position 3:	
Position 4:	
Position 5:	
Position 6:	
Position 7:	
Position 8:	
Position 9:	
Position 10:	

Font Information:

--

Remarks:

Information about BOSCH CRI with IQA-Function

DAIMLER

Image Caption:

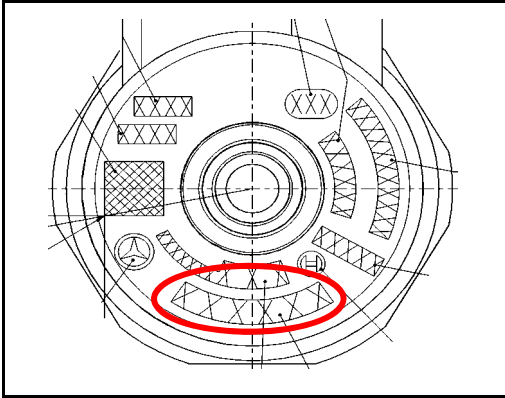

Affected Injector SNr.:

0 445 110 139	0 445 110 137
0 445 110 140	0 445 110 138
0 445 110 162	0 445 110 263
0 445 110 163	0 445 110 264
0 445 110 166	0 445 110 294
0 445 110 167	0 445 110 295
0 445 110 176	
0 445 110 177	
0 445 110 191	
0 445 110 192	
0 445 110 193	
0 445 110 194	

IQA-Code: (Example)

BS1LB5	
Position 1:	IQA-Code, Mandatory Input
Position 2:	IQA-Code, Mandatory Input
Position 3:	IQA-Code, Mandatory Input
Position 4:	IQA-Code, Mandatory Input
Position 5:	IQA-Code, Mandatory Input
Position 6:	IQA-Code, Mandatory Input
Position 7:	Not Used
Position 8:	Not Used
Position 9:	Not Used
Position 10:	Not Used

Font Information:

Regular type according to DIN 1451
with crossed out Zero

Remarks:

Information about BOSCH CRI with IQA-Function

DAIMLER

Image Caption:

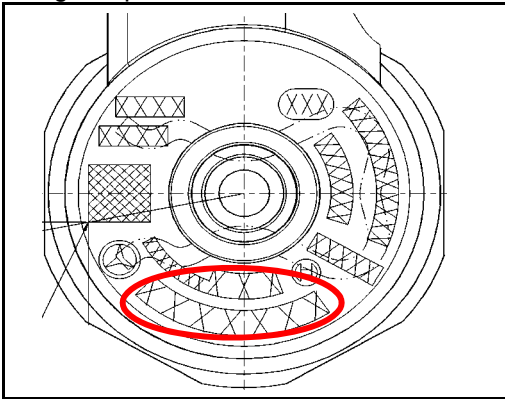

Affected Injector SNr.:

0 445 110 237	
0 445 110 238	

IQA-Code: (Example)

7RHH3A5	
Position 1:	IQA-Code, Mandatory Input
Position 2:	IQA-Code, Mandatory Input
Position 3:	IQA-Code, Mandatory Input
Position 4:	IQA-Code, Mandatory Input
Position 5:	IQA-Code, Mandatory Input
Position 6:	IQA-Code, Mandatory Input
Position 7:	IQA-Code, Mandatory Input
Position 8:	Not Used
Position 9:	Not Used
Position 10:	Not Used

Font Information:

Regular type according to DIN 1451
with crossed out Zero

Remarks:

Information about BOSCH CRI with IQA-Function

DAIMLER

Image Caption:

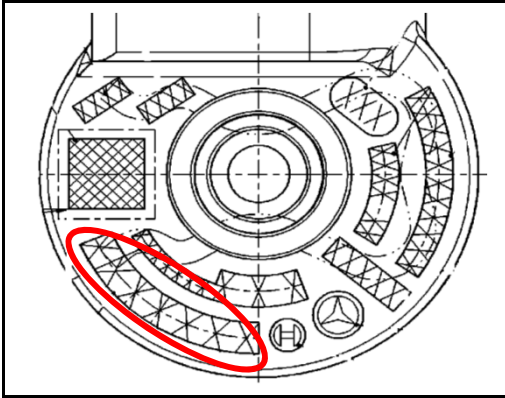

Affected Injector SNr.:

0 445 110 302	
0 445 110 303	
0 445 110 377	
0 445 110 378	

IQA-Code: (Example)

7RHH3A5	
Position 1:	IQA-Code, Mandatory Input
Position 2:	IQA-Code, Mandatory Input
Position 3:	IQA-Code, Mandatory Input
Position 4:	IQA-Code, Mandatory Input
Position 5:	IQA-Code, Mandatory Input
Position 6:	IQA-Code, Mandatory Input
Position 7:	IQA-Code, Mandatory Input
Position 8:	Not Used
Position 9:	Not Used
Position 10:	Not Used

Font Information:

Regular type according to DIN 1451
with crossed out Zero

Remarks:

Information about BOSCH CRI with IQA-Function

DA-INDIA

Image Caption:

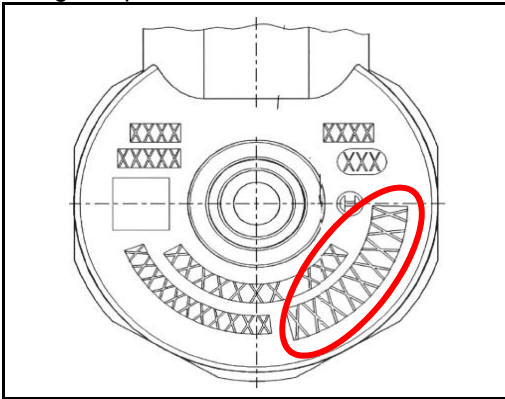

Affected Injector SNr.:

0 445 110 519	

IQA-Code: (Example)

7RHH3A5	
Position 1:	IQA-Code, Mandatory Input
Position 2:	IQA-Code, Mandatory Input
Position 3:	IQA-Code, Mandatory Input
Position 4:	IQA-Code, Mandatory Input
Position 5:	IQA-Code, Mandatory Input
Position 6:	IQA-Code, Mandatory Input
Position 7:	IQA-Code, Mandatory Input
Position 8:	No Opinion
Position 9:	No Opinion
Position 10:	Not Used

Font Information:

OCR-A according to DIN66008

Remarks:

Information about BOSCH CRI with IQA-Function

FIAT, GM

Image Caption:

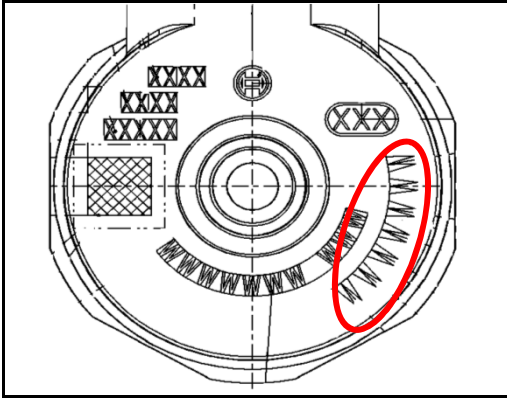

Affected Injector SNr.:

0 445 110 424	

IQA-Code: (Example)

7RRX8I5	
Position 1:	IQA-Code, Mandatory Input
Position 2:	IQA-Code, Mandatory Input
Position 3:	IQA-Code, Mandatory Input
Position 4:	IQA-Code, Mandatory Input
Position 5:	IQA-Code, Mandatory Input
Position 6:	IQA-Code, Mandatory Input
Position 7:	IQA-Code, Mandatory Input
Position 8:	Not Used
Position 9:	Not Used
Position 10:	Not Used

Font Information:

Regular type according to DIN 1451
with crossed out Zero

Remarks:

GM

Information about BOSCH CRI with IQA-Function

Image Caption:

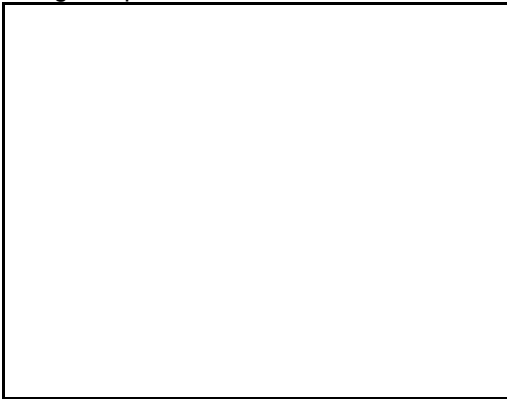

Affected Injector SNr.:

IQA-Code: (Example)

Position 1:	
Position 2:	
Position 3:	
Position 4:	
Position 5:	
Position 6:	
Position 7:	
Position 8:	
Position 9:	
Position 10:	

Font Information:

Remarks:

Information about BOSCH CRI with IQA-Function

IVECO

Image Caption:

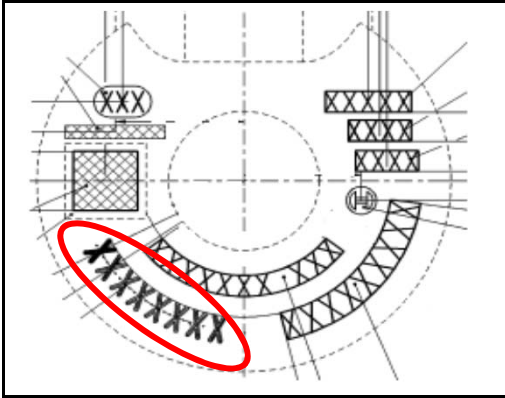

Affected Injector SNr.:

0 445 110 247	
0 445 110 248	
0 445 110 273	
0 445 110 435	
0 445 110 520	

IQA-Code: (Example)

7RHH3A5X	
Position 1:	IQA-Code, Mandatory Input
Position 2:	IQA-Code, Mandatory Input
Position 3:	IQA-Code, Mandatory Input
Position 4:	IQA-Code, Mandatory Input
Position 5:	IQA-Code, Mandatory Input
Position 6:	IQA-Code, Mandatory Input
Position 7:	IQA-Code, Mandatory Input
Position 8:	Engine identifier, no opinion
Position 9:	Not Used
Position 10:	Not Used

Font Information:

Regular type according to DIN 1451
with crossed out Zero

Remarks:

Information about BOSCH CRI with IQA-Function

IVECO

Image Caption:

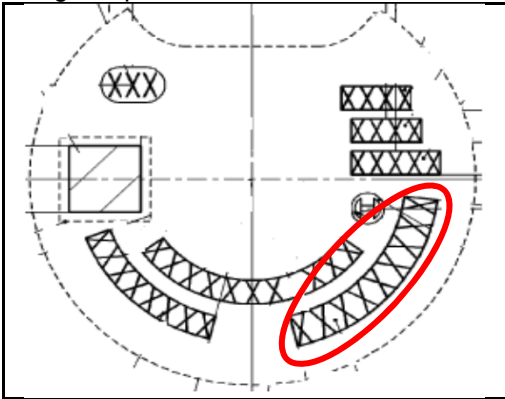

Affected Injector SNr.:

0 445 110 457	
0 445 110 540	

IQA-Code: (Example)

8RIX71C	
Position 1:	IQA-Code, Mandatory Input
Position 2:	IQA-Code, Mandatory Input
Position 3:	IQA-Code, Mandatory Input
Position 4:	IQA-Code, Mandatory Input
Position 5:	IQA-Code, Mandatory Input
Position 6:	IQA-Code, Mandatory Input
Position 7:	IQA-Code, Mandatory Input
Position 8:	Not Used
Position 9:	Not Used
Position 10:	Not Used

Font Information:

Regular type according to DIN 1451
with crossed out Zero

Remarks:

Information about BOSCH CRI with IQA-Function

HONDA

Image Caption:

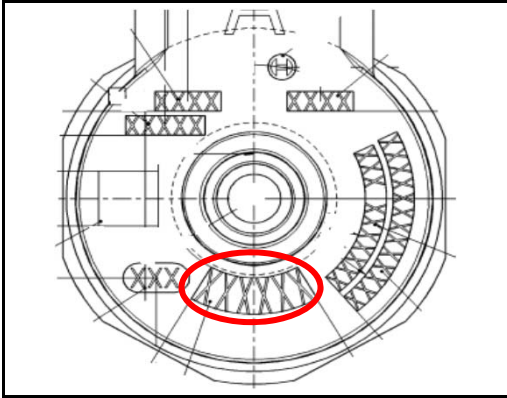

Affected Injector SNr.:

0 445 110 236	
0 445 110 172	
0 445 110 288	
0 445 110 296	

IQA-Code: (Example)

81RZ80	
Position 1:	IQA-Code, Mandatory Input
Position 2:	IQA-Code, Mandatory Input
Position 3:	IQA-Code, Mandatory Input
Position 4:	IQA-Code, Mandatory Input
Position 5:	IQA-Code, Mandatory Input
Position 6:	IQA-Code, Mandatory Input
Position 7:	Not Used
Position 8:	Not Used
Position 9:	Not Used
Position 10:	Not Used

Font Information:

Bosch FNT

Remarks:

Information about BOSCH CRI with IQA-Function

HONDA

Image Caption:

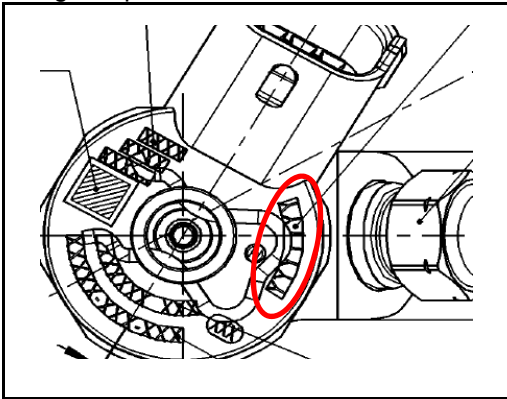

Affected Injector SNr.:

0 445 110 547	

IQA-Code: (Example)

Position 1:	IQA-Code, Mandatory Input
Position 2:	IQA-Code, Mandatory Input
Position 3:	IQA-Code, Mandatory Input
Position 4:	IQA-Code, Mandatory Input
Position 5:	IQA-Code, Mandatory Input
Position 6:	IQA-Code, Mandatory Input
Position 7:	Not Used
Position 8:	Not Used
Position 9:	Not Used
Position 10:	Not Used

Font Information:

--

Remarks:

Information about BOSCH CRI with IQA-Function

HONDA

Image Caption:

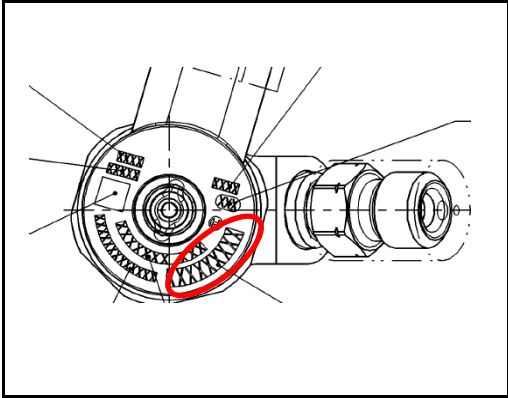

Affected Injector SNr.:

0 445 110 532	

IQA-Code: (Example)

Position 1:	IQA-Code, Mandatory Input
Position 2:	IQA-Code, Mandatory Input
Position 3:	IQA-Code, Mandatory Input
Position 4:	IQA-Code, Mandatory Input
Position 5:	IQA-Code, Mandatory Input
Position 6:	IQA-Code, Mandatory Input
Position 7:	Not Used
Position 8:	Not Used
Position 9:	Not Used
Position 10:	Not Used

Font Information:

--

Remarks:

--

Information about BOSCH CRI with IQA-Function

MAHINDRA

Image Caption:

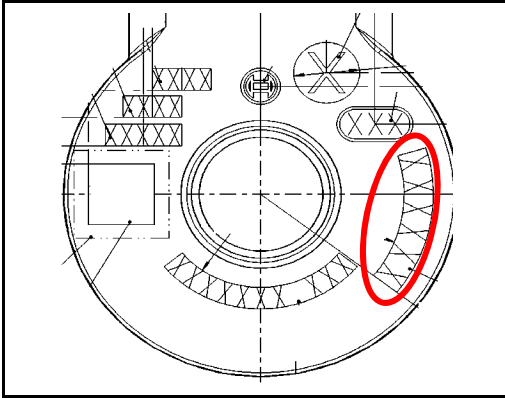

Affected Injector SNr.:

0 445 110 260	

IQA-Code: (Example)

AH1UDWD	
Position 1:	IQA-Code, Mandatory Input
Position 2:	IQA-Code, Mandatory Input
Position 3:	IQA-Code, Mandatory Input
Position 4:	IQA-Code, Mandatory Input
Position 5:	IQA-Code, Mandatory Input
Position 6:	IQA-Code, Mandatory Input
Position 7:	IQA-Code, Mandatory Input
Position 8:	Not Used
Position 9:	Not Used
Position 10:	Not Used

Font Information:

Zero nearly rectangular

Remarks:

Information about BOSCH CRI with IQA-Function

MAHINDRA

Image Caption:

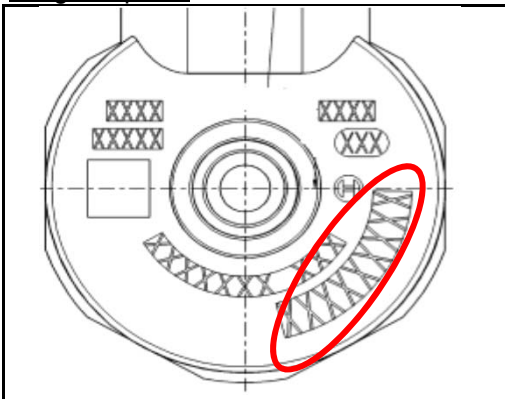

Affected Injector SNr.:

0 445 110 310	
0 445 110 342	

IQA-Code: (Example)

.AH1UDWD_	
Position 1:	No Opinion
Position 2:	IQA-Code, Mandatory Input
Position 3:	IQA-Code, Mandatory Input
Position 4:	IQA-Code, Mandatory Input
Position 5:	IQA-Code, Mandatory Input
Position 6:	IQA-Code, Mandatory Input
Position 7:	IQA-Code, Mandatory Input
Position 8:	IQA-Code, Mandatory Input
Position 9:	No Opinion
Position 10:	Not Used

Font Information:

OCR-A according to DIN66008

Remarks:

Information about BOSCH CRI with IQA-Function

MAHINDRA

Image Caption:

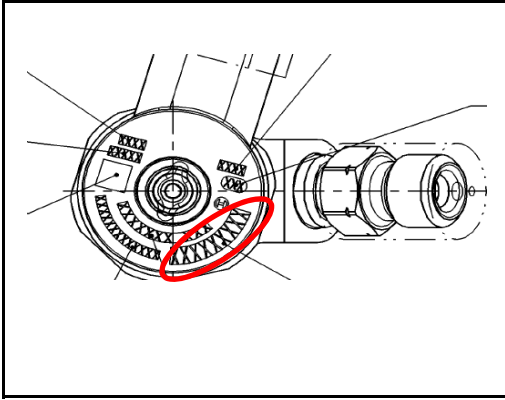

Affected Injector SNr.:

0 445 110 557	
0 445 110 496	
0 445 110 580	
0 445 110 441	

IQA-Code: (Example)

AH1UDW	
Position 1:	IQA-Code, Mandatory Input
Position 2:	IQA-Code, Mandatory Input
Position 3:	IQA-Code, Mandatory Input
Position 4:	IQA-Code, Mandatory Input
Position 5:	IQA-Code, Mandatory Input
Position 6:	IQA-Code, Mandatory Input
Position 7:	Not Used
Position 8:	Not Used
Position 9:	Not Used
Position 10:	Not Used

Font Information:

OCR-A according to DIN66008

Remarks:

--

Information about BOSCH CRI with IQA-Function

MAZDA

Image Caption:

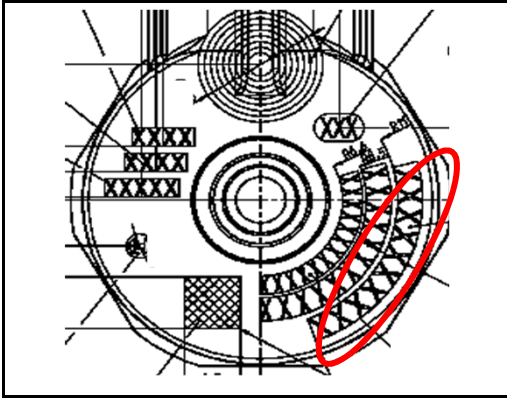

Affected Injector SNr.:

0 445 110 249	
0 445 110 250	

IQA-Code: (Example)

042FE150B0	
Position 1:	IQA-Code, Mandatory Input
Position 2:	IQA-Code, Mandatory Input
Position 3:	IQA-Code, Mandatory Input
Position 4:	IQA-Code, Mandatory Input
Position 5:	IQA-Code, Mandatory Input
Position 6:	IQA-Code, Mandatory Input
Position 7:	IQA-Code, Mandatory Input
Position 8:	IQA-Code, Mandatory Input
Position 9:	Engine identifier, no opinion
Position 10:	Engine identifier, no opinion

Font Information:

Bosch FNT

Remarks:

Information about BOSCH CRI with IQA-Function

Image Caption:

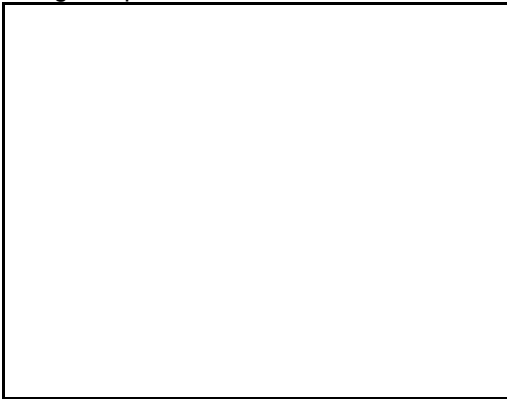

Affected Injector SNr.:

IQA-Code: (Example)

Position 1:	
Position 2:	
Position 3:	
Position 4:	
Position 5:	
Position 6:	
Position 7:	
Position 8:	
Position 9:	
Position 10:	

Font Information:

--

Remarks:

Information about BOSCH CRI with IQA-Function

M&M

Image Caption:

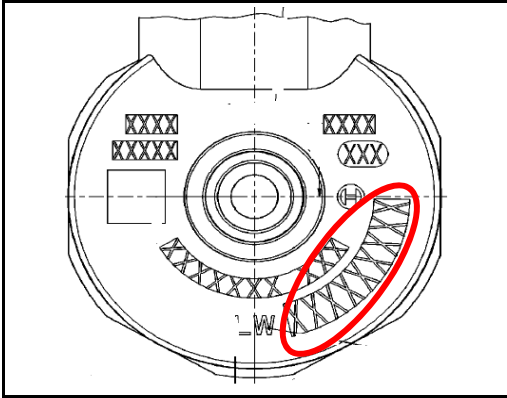

Affected Injector SNr.:

0 445 110 545	

IQA-Code: (Example)

8RIX71C	
Position 1:	IMA-Code, Pflichtangabe
Position 2:	IMA-Code, Pflichtangabe
Position 3:	IMA-Code, Pflichtangabe
Position 4:	IMA-Code, Pflichtangabe
Position 5:	IMA-Code, Pflichtangabe
Position 6:	IMA-Code, Pflichtangabe
Position 7:	IMA-Code, Pflichtangabe
Position 8:	keine Eingabe
Position 9:	keine Eingabe
Position 10:	nicht belegt

Font Information:

OCR-A according to DIN66008 part 1

Remarks:

Information about BOSCH CRI with IQA-Function

Image Caption:

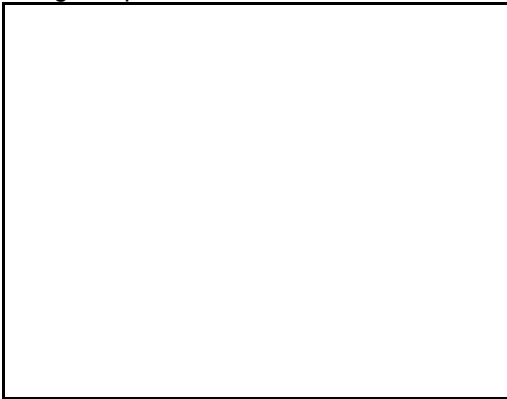

Affected Injector SNr.:

IQA-Code: (Example)

Position 1:	
Position 2:	
Position 3:	
Position 4:	
Position 5:	
Position 6:	
Position 7:	
Position 8:	
Position 9:	
Position 10:	

Font Information:

Remarks:

Information about BOSCH CRI with IQA-Function

NISSAN

Image Caption:

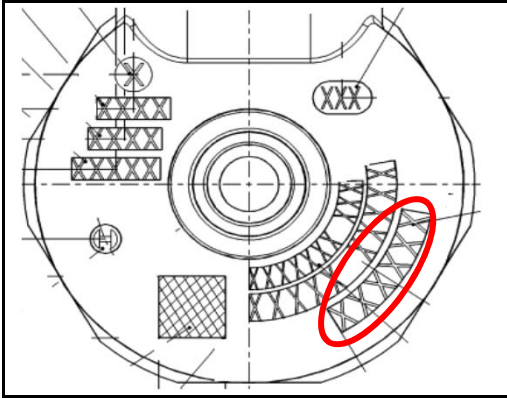

Affected Injector SNr.:

0 445 110 168	
0 445 110 169	
0 445 110 284	
0 445 110 315	
0 445 110 797	

IQA-Code: (Example)

CAH30S	
Position 1:	IQA-Code, Mandatory Input
Position 2:	IQA-Code, Mandatory Input
Position 3:	IQA-Code, Mandatory Input
Position 4:	IQA-Code, Mandatory Input
Position 5:	IQA-Code, Mandatory Input
Position 6:	IQA-Code, Mandatory Input
Position 7:	Not Used
Position 8:	Not Used
Position 9:	Not Used
Position 10:	Not Used

Font Information:

Bosch FNT

Remarks:

Information about BOSCH CRI with IQA-Function

Image Caption:

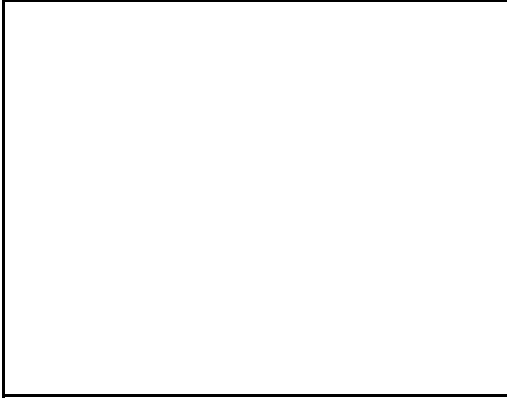

Affected Injector SNr.:

IQA-Code: (Example)

Position 1:	
Position 2:	
Position 3:	
Position 4:	
Position 5:	
Position 6:	
Position 7:	
Position 8:	
Position 9:	
Position 10:	

Font Information:

--

Remarks:

Information about BOSCH CRI with IQA-Function

PSA

Image Caption:

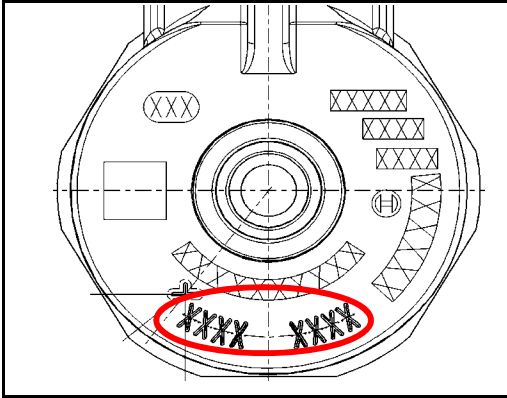

Affected Injector SNr.:

0 445 110 135	
0 445 110 136	
0 445 110 285	

IQA-Code: (Example)

0C8F C0D0	
Position 1:	IQA-Code, Mandatory Input
Position 2:	IQA-Code, Mandatory Input
Position 3:	IQA-Code, Mandatory Input
Position 4:	IQA-Code, Mandatory Input
Position 5:	IQA-Code, Mandatory Input
Position 6:	IQA-Code, Mandatory Input
Position 7:	IQA-Code, Mandatory Input
Position 8:	IQA-Code, Mandatory Input
Position 9:	Not Used
Position 10:	Not Used

Font Information:

Zero not crossed out
Zero nearly rectangular

Remarks:

Information about BOSCH CRI with IQA-Function

PSA

Image Caption:

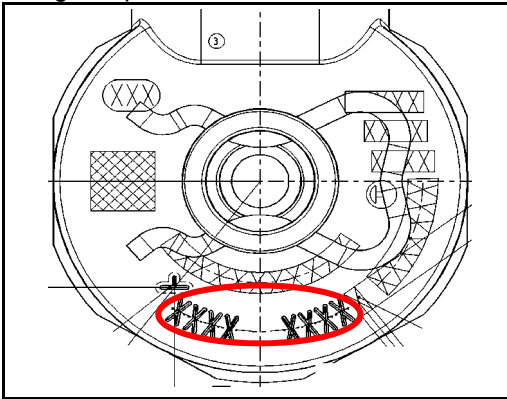

Affected Injector SNr.:

0 445 110 188	

IQA-Code: (Example)

0050 A0B04	
Position 1:	IQA-Code, Mandatory Input
Position 2:	IQA-Code, Mandatory Input
Position 3:	IQA-Code, Mandatory Input
Position 4:	IQA-Code, Mandatory Input
Position 5:	IQA-Code, Mandatory Input
Position 6:	IQA-Code, Mandatory Input
Position 7:	IQA-Code, Mandatory Input
Position 8:	IQA-Code, Mandatory Input
Position 9:	EU-classification, no opinion
Position 10:	Not Used

Font Information:

Zero not crossed out
Zero nearly rectangular

Remarks:

Information about BOSCH CRI with IQA-Function

PSA

Image Caption:

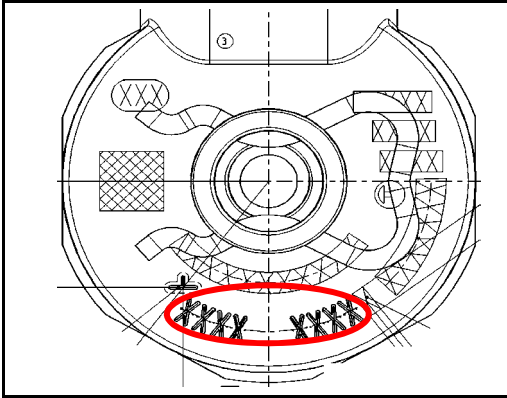

Affected Injector SNr.:

0 445 110 239	

IQA-Code: (Example)

F3A0 7F507	
Position 1:	IQA-Code, Mandatory Input
Position 2:	IQA-Code, Mandatory Input
Position 3:	IQA-Code, Mandatory Input
Position 4:	IQA-Code, Mandatory Input
Position 5:	IQA-Code, Mandatory Input
Position 6:	IQA-Code, Mandatory Input
Position 7:	IQA-Code, Mandatory Input
Position 8:	IQA-Code, Mandatory Input
Position 9:	Mapping SNR, no opinion
Position 10:	Not Used

Font Information:

Zero not crossed out
Zero nearly rectangular

Remarks:

Information about BOSCH CRI with IQA-Function

PSA

Image Caption:

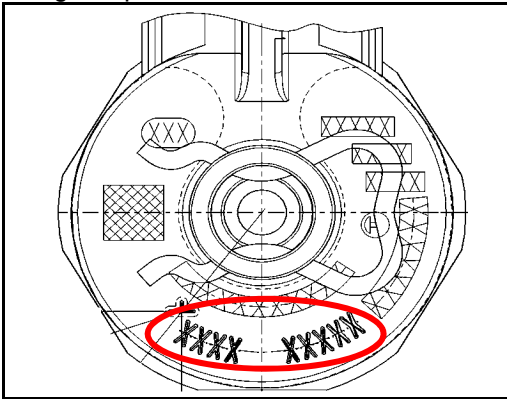

Affected Injector SNr.:

0 445 110 252	
0 445 110 281	
0 445 110 297	
0 445 110 311	

IQA-Code: (Example)

FFEE BFF80	
Position 1:	IQA-Code, Mandatory Input
Position 2:	IQA-Code, Mandatory Input
Position 3:	IQA-Code, Mandatory Input
Position 4:	IQA-Code, Mandatory Input
Position 5:	IQA-Code, Mandatory Input
Position 6:	IQA-Code, Mandatory Input
Position 7:	IQA-Code, Mandatory Input
Position 8:	IQA-Code, Mandatory Input
Position 9:	IQA-Code, Mandatory Input
Position 10:	not used or engine identifier

Font Information:

Zero not crossed out
Zero nearly rectangular

Remarks:

Information about BOSCH CRI with IQA-Function

PSA, FORD

Image Caption:

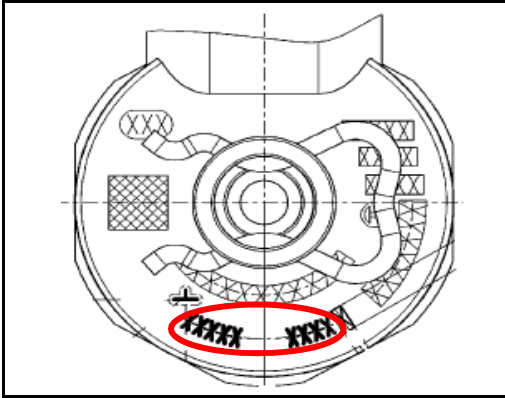

Affected Injector SNr.:

0 445 110 339	
0 445 110 340	
0 445 110 489	
0 445 110 565	
0 445 110 566	
0 445 110 739	

IQA-Code: (Example)

FFEE BFF80	
Position 1:	IQA-Code, Mandatory Input
Position 2:	IQA-Code, Mandatory Input
Position 3:	IQA-Code, Mandatory Input
Position 4:	IQA-Code, Mandatory Input
Position 5:	IQA-Code, Mandatory Input
Position 6:	IQA-Code, Mandatory Input
Position 7:	IQA-Code, Mandatory Input
Position 8:	IQA-Code, Mandatory Input
Position 9:	IQA-Code, Mandatory Input
Position 10:	not used or engine identifier

Font Information:

OCR-A according to DIN66008 part 1

Remarks:

Information about BOSCH CRI with IQA-Function

FORD

Image Caption:

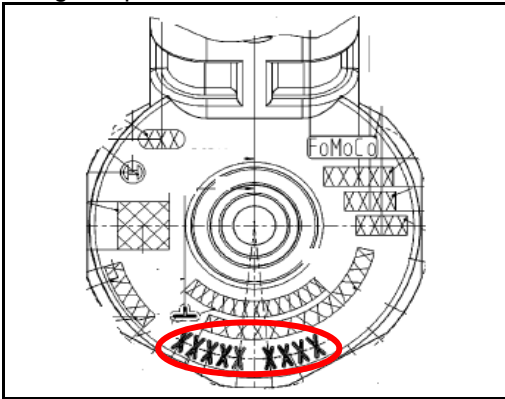

Affected Injector SNr.:

0 445 110 353	
0 445 110 352	

IQA-Code: (Example)

FFEE BFF80	
Position 1:	IQA-Code, Mandatory Input
Position 2:	IQA-Code, Mandatory Input
Position 3:	IQA-Code, Mandatory Input
Position 4:	IQA-Code, Mandatory Input
Position 5:	IQA-Code, Mandatory Input
Position 6:	IQA-Code, Mandatory Input
Position 7:	IQA-Code, Mandatory Input
Position 8:	IQA-Code, Mandatory Input
Position 9:	IQA-Code, Mandatory Input
Position 10:	Not Used

Font Information:

OCR-A according to DIN66008 part 1

Remarks:

Information about BOSCH CRI with IQA-Function

RENAULT

Image Caption:

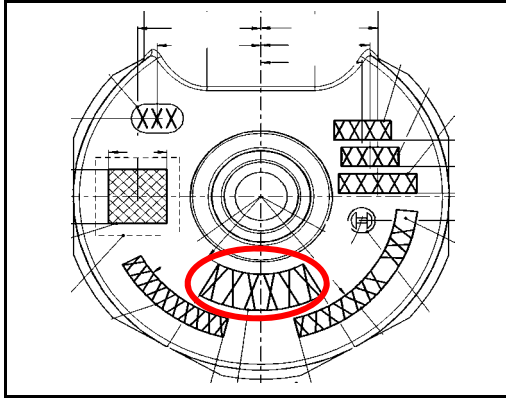

Affected Injector SNr.:

0 445 110 084	
0 445 110 109	
0 445 110 110	
0 445 110 127	
0 445 110 144	
0 445 110 160	
0 445 110 178	
0 445 110 230	

IQA-Code: (Example)

81RZ80	
Position 1:	IQA-Code, Mandatory Input
Position 2:	IQA-Code, Mandatory Input
Position 3:	IQA-Code, Mandatory Input
Position 4:	IQA-Code, Mandatory Input
Position 5:	IQA-Code, Mandatory Input
Position 6:	IQA-Code, Mandatory Input
Position 7:	Not Used
Position 8:	Not Used
Position 9:	Not Used
Position 10:	Not Used

Font Information:

Zero not crossed out
Zero nearly rectangular

Remarks:

Information about BOSCH CRI with IQA-Function

RENAULT

Image Caption:

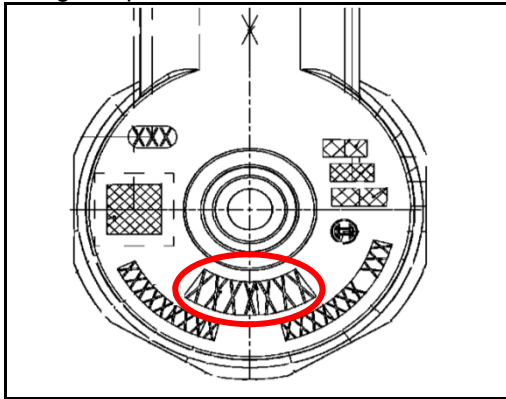

Affected Injector SNr.:

0 445 110 265	
0 445 110 280	
0 445 110 261	
0 445 110 338	
0 445 110 328	
0 445 110 375	
0 445 110 485	
0 445 110 414	

IQA-Code: (Example)

7RHH3A5	
Position 1:	IQA-Code, Mandatory Input
Position 2:	IQA-Code, Mandatory Input
Position 3:	IQA-Code, Mandatory Input
Position 4:	IQA-Code, Mandatory Input
Position 5:	IQA-Code, Mandatory Input
Position 6:	IQA-Code, Mandatory Input
Position 7:	IQA-Code, Mandatory Input
Position 8:	Not Used
Position 9:	Not Used
Position 10:	Not Used

Font Information:

OCR-A according to DIN66008

Remarks:

Information about BOSCH CRI with IQA-Function

SISU

Image Caption:

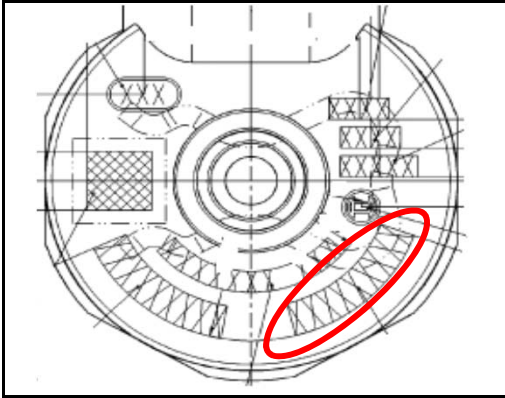

Affected Injector SNr.:

0 445 110 381	

IQA-Code: (Example)

8RIX71C	
Position 1:	IQA-Code, Mandatory Input
Position 2:	IQA-Code, Mandatory Input
Position 3:	IQA-Code, Mandatory Input
Position 4:	IQA-Code, Mandatory Input
Position 5:	IQA-Code, Mandatory Input
Position 6:	IQA-Code, Mandatory Input
Position 7:	IQA-Code, Mandatory Input
Position 8:	Not Used
Position 9:	Not Used
Position 10:	Not Used

Font Information:

Regular type according to DIN 1451
with crossed out Zero

Remarks:

Information about BOSCH CRI with IQA-Function

AGCO SISU

Image Caption:

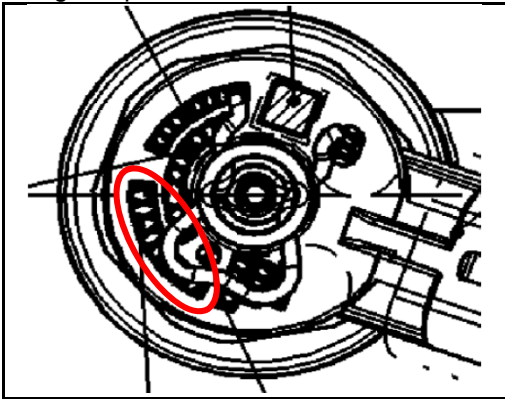

Affected Injector SNr.:

0 445 110 408	

IQA-Code: (Example)

8RIX71C	
Position 1:	IQA-Code, Mandatory Input
Position 2:	IQA-Code, Mandatory Input
Position 3:	IQA-Code, Mandatory Input
Position 4:	IQA-Code, Mandatory Input
Position 5:	IQA-Code, Mandatory Input
Position 6:	IQA-Code, Mandatory Input
Position 7:	IQA-Code, Mandatory Input
Position 8:	Not Used
Position 9:	Not Used
Position 10:	Not Used

Font Information:

Remarks:

Information about BOSCH CRI with IQA-Function

TATA

Image Caption:

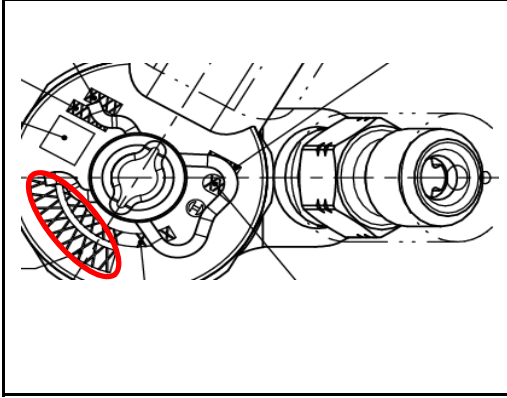

Affected Injector SNr.:

0 445 110 506	

IQA-Code: (Example)

AH1UDWD	
Position 1:	IQA-Code, Mandatory Input
Position 2:	IQA-Code, Mandatory Input
Position 3:	IQA-Code, Mandatory Input
Position 4:	IQA-Code, Mandatory Input
Position 5:	IQA-Code, Mandatory Input
Position 6:	IQA-Code, Mandatory Input
Position 7:	IQA-Code, Mandatory Input
Position 8:	Not Used
Position 9:	Not Used
Position 10:	Not Used

Font Information:

Zero nearly rectangular

Remarks:

--

Information about BOSCH CRI with IQA-Function

VM

Image Caption:

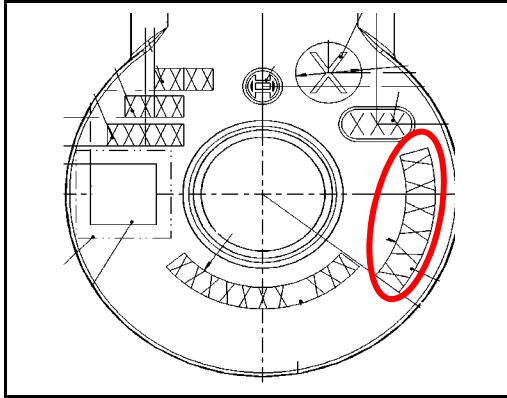

Affected Injector SNr.:

0 445 110 217	
0 445 110 218	
0 445 110 286	

IQA-Code: (Example)

CAH30S	
Position 1:	IQA-Code, Mandatory Input
Position 2:	IQA-Code, Mandatory Input
Position 3:	IQA-Code, Mandatory Input
Position 4:	IQA-Code, Mandatory Input
Position 5:	IQA-Code, Mandatory Input
Position 6:	IQA-Code, Mandatory Input
Position 7:	Not Used
Position 8:	Not Used
Position 9:	Not Used
Position 10:	Not Used

Font Information:

Zero not crossed out
Zero nearly rectangular

Remarks:

Information about BOSCH CRI with IQA-Function

VM

Image Caption:

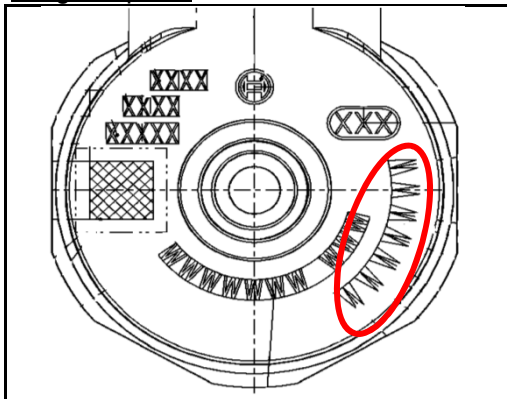

Affected Injector SNr.:

0 445 110 301	
0 445 110 354	

IQA-Code: (Example)

7RRX8I5	
Position 1:	IQA-Code, Mandatory Input
Position 2:	IQA-Code, Mandatory Input
Position 3:	IQA-Code, Mandatory Input
Position 4:	IQA-Code, Mandatory Input
Position 5:	IQA-Code, Mandatory Input
Position 6:	IQA-Code, Mandatory Input
Position 7:	IQA-Code, Mandatory Input
Position 8:	Not Used
Position 9:	Not Used
Position 10:	Not Used

Font Information:

Regular type according to DIN 1451
with crossed out Zero

Remarks:

Information about BOSCH CRI with IQA-Function

VM

Image Caption:

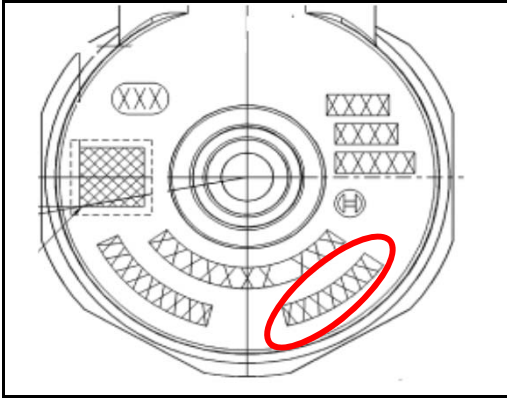

Affected Injector SNr.:

0 445 110 400	
0 445 110 543	

IQA-Code: (Example)

7RRX8 I 5	
Position 1:	IQA-Code, Mandatory Input
Position 2:	IQA-Code, Mandatory Input
Position 3:	IQA-Code, Mandatory Input
Position 4:	IQA-Code, Mandatory Input
Position 5:	IQA-Code, Mandatory Input
Position 6:	IQA-Code, Mandatory Input
Position 7:	IQA-Code, Mandatory Input
Position 8:	Not Used
Position 9:	Not Used
Position 10:	Not Used

Font Information:

Regular type according to DIN 1451
with crossed out Zero

Remarks:

Information about BOSCH CRI with IQA-Function

VM

Image Caption:

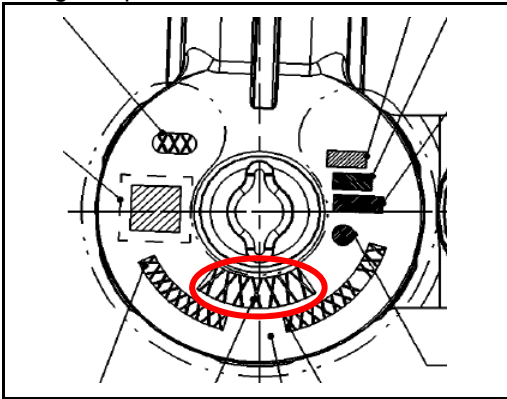

Affected Injector SNr.:

0445110430	

IQA-Code: (Example)

7RRX8 I 5	
Position 1:	IQA-Code, Mandatory Input
Position 2:	IQA-Code, Mandatory Input
Position 3:	IQA-Code, Mandatory Input
Position 4:	IQA-Code, Mandatory Input
Position 5:	IQA-Code, Mandatory Input
Position 6:	IQA-Code, Mandatory Input
Position 7:	IQA-Code, Mandatory Input
Position 8:	
Position 9:	
Position 10:	

Font Information:

Regular type according to DIN 1451
with crossed out Zero

Remarks:

Information about BOSCH CRI with IQA-Function

VOLVO

Image Caption:

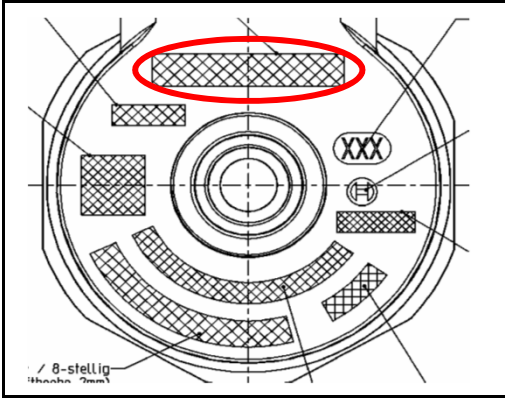

Affected Injector SNr.:

0 445 110 251	

IQA-Code: (Example)

BA2EDS G1	
Position 1:	Identifier, no opinion
Position 2:	IQA-Code, Mandatory Input
Position 3:	IQA-Code, Mandatory Input
Position 4:	IQA-Code, Mandatory Input
Position 5:	IQA-Code, Mandatory Input
Position 6:	IQA-Code, Mandatory Input
Position 7:	IQA-Code, Mandatory Input
Position 8:	Not Used
Position 9:	Not Used
Position 10:	Not Used

Font Information:

OCR-A according to DIN66008

Remarks:

Information about BOSCH CRI with IQA-Function

VOLVO

Image Caption:

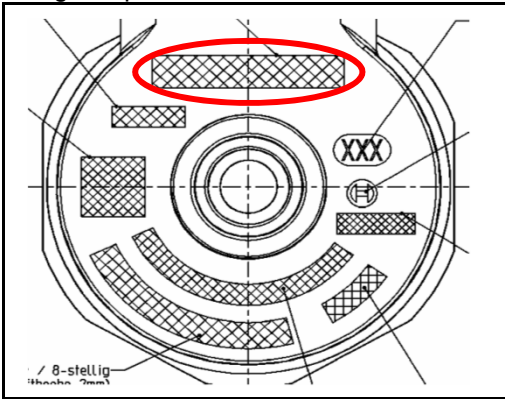

Affected Injector SNr.:

0 445 110 298	

IQA-Code: (Example)

5ASILI5K	
Position 1:	Identifier, no opinion
Position 2:	IQA-Code, Mandatory Input
Position 3:	IQA-Code, Mandatory Input
Position 4:	IQA-Code, Mandatory Input
Position 5:	IQA-Code, Mandatory Input
Position 6:	IQA-Code, Mandatory Input
Position 7:	IQA-Code, Mandatory Input
Position 8:	IQA-Code, Mandatory Input
Position 9:	Not Used
Position 10:	Not Used

Font Information:

OCR-A according to DIN66008

Remarks:

Information about BOSCH CRI with IQA-Function

VW

Image Caption:

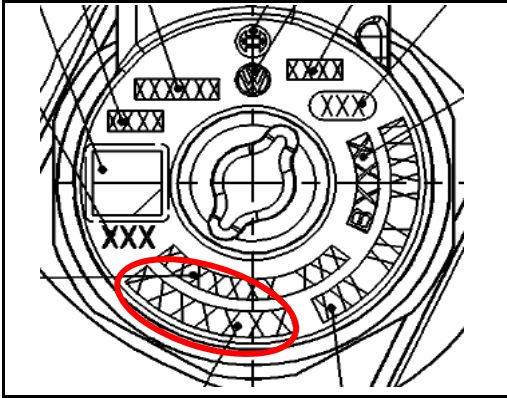

Affected Injector SNr.:

0 445 110 368	
0 445 110 369	
0 445 110 646	
0 445 110 647	
0 986 435 166	
0 986 435 167	
0 445 110 688	
0 445 110 689	

IQA-Code: (Example)

6G8M3A	
Position 1:	IQA-Code, Mandatory Input
Position 2:	IQA-Code, Mandatory Input
Position 3:	IQA-Code, Mandatory Input
Position 4:	IQA-Code, Mandatory Input
Position 5:	IQA-Code, Mandatory Input
Position 6:	IQA-Code, Mandatory Input
Position 7:	IQA-Code, Mandatory Input
Position 8:	Not Used
Position 9:	Not Used
Position 10:	Not Used

Font Information:

--

Remarks:

--

Information about BOSCH CRI with IQA-Function

Image Caption:

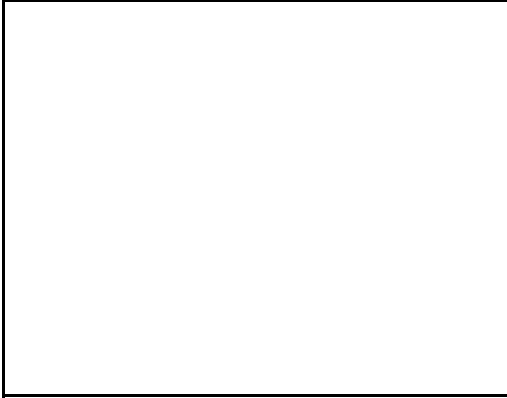

Affected Injector SNr.:

IQA-Code: (Example)

Position 1:	
Position 2:	
Position 3:	
Position 4:	
Position 5:	
Position 6:	
Position 7:	
Position 8:	
Position 9:	
Position 10:	

Font Information:

--

Remarks:

--

Information about BOSCH CRI with IQA-Function

Yanmar

Image Caption:

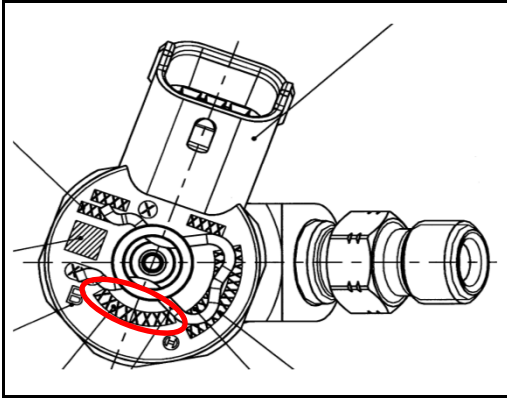

Affected Injector SNr.:

0 445 110 507	
0 445 110 508	
0 445 110 463	
0 445 110 464	
0 445 110 577	
0 445 110 679	

IQA-Code: (Example)

8ZZK1W3A	
Position 1:	IQA-Code, Mandatory Input
Position 2:	IQA-Code, Mandatory Input
Position 3:	IQA-Code, Mandatory Input
Position 4:	IQA-Code, Mandatory Input
Position 5:	IQA-Code, Mandatory Input
Position 6:	IQA-Code, Mandatory Input
Position 7:	IQA-Code, Mandatory Input
Position 8:	Not Used
Position 9:	Not Used
Position 10:	Not Used

Font Information:

--

Remarks:

Yanmar

Information about BOSCH CRI with IQA-Function

Image Caption:

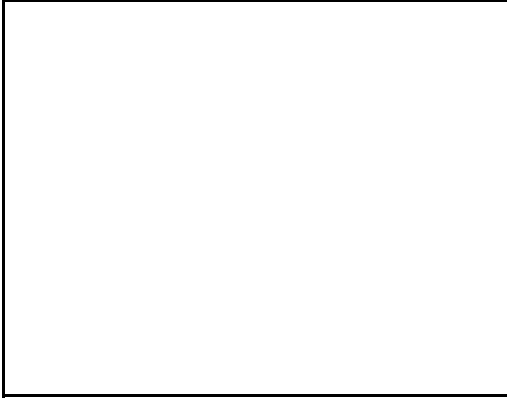

Affected Injector SNr.:

IQA-Code: (Example)

Position 1:	
Position 2:	
Position 3:	
Position 4:	
Position 5:	
Position 6:	
Position 7:	
Position 8:	
Position 9:	
Position 10:	

Font Information:

--

Remarks:

--

Information about BOSCH CRI with IQA-Function

ZMZ

Image Caption:

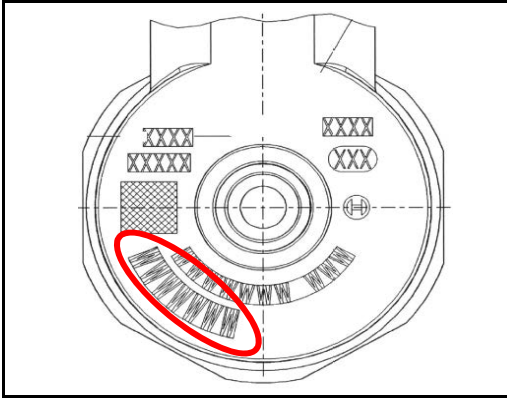

Affected Injector SNr.:

0 445 110 502	

IQA-Code: (Example)

8RIX71C	
Position 1:	IQA-Code, Mandatory Input
Position 2:	IQA-Code, Mandatory Input
Position 3:	IQA-Code, Mandatory Input
Position 4:	IQA-Code, Mandatory Input
Position 5:	IQA-Code, Mandatory Input
Position 6:	IQA-Code, Mandatory Input
Position 7:	IQA-Code, Mandatory Input
Position 8:	Not Used
Position 9:	Not Used
Position 10:	Not Used

Font Information:

Regular type according to DIN 1451
with crossed out Zero

Remarks:

Information about BOSCH CRI with IQA-Function

Image Caption:

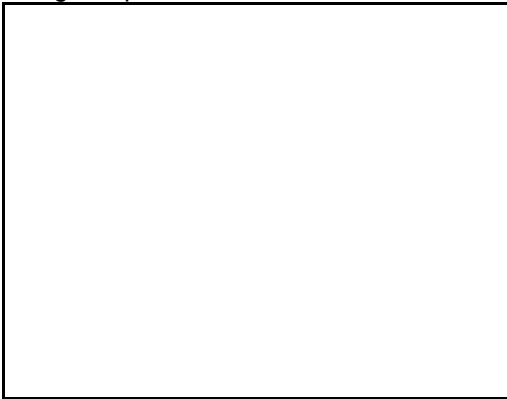

Affected Injector SNr.:

IQA-Code: (Example)

Position 1:	
Position 2:	
Position 3:	
Position 4:	
Position 5:	
Position 6:	
Position 7:	
Position 8:	
Position 9:	
Position 10:	

Font Information:

Remarks: